

NOTES:-
1. ALL DIMENSIONS ARE IN MM. UNLESS OTHERWISE SPECIFIED.

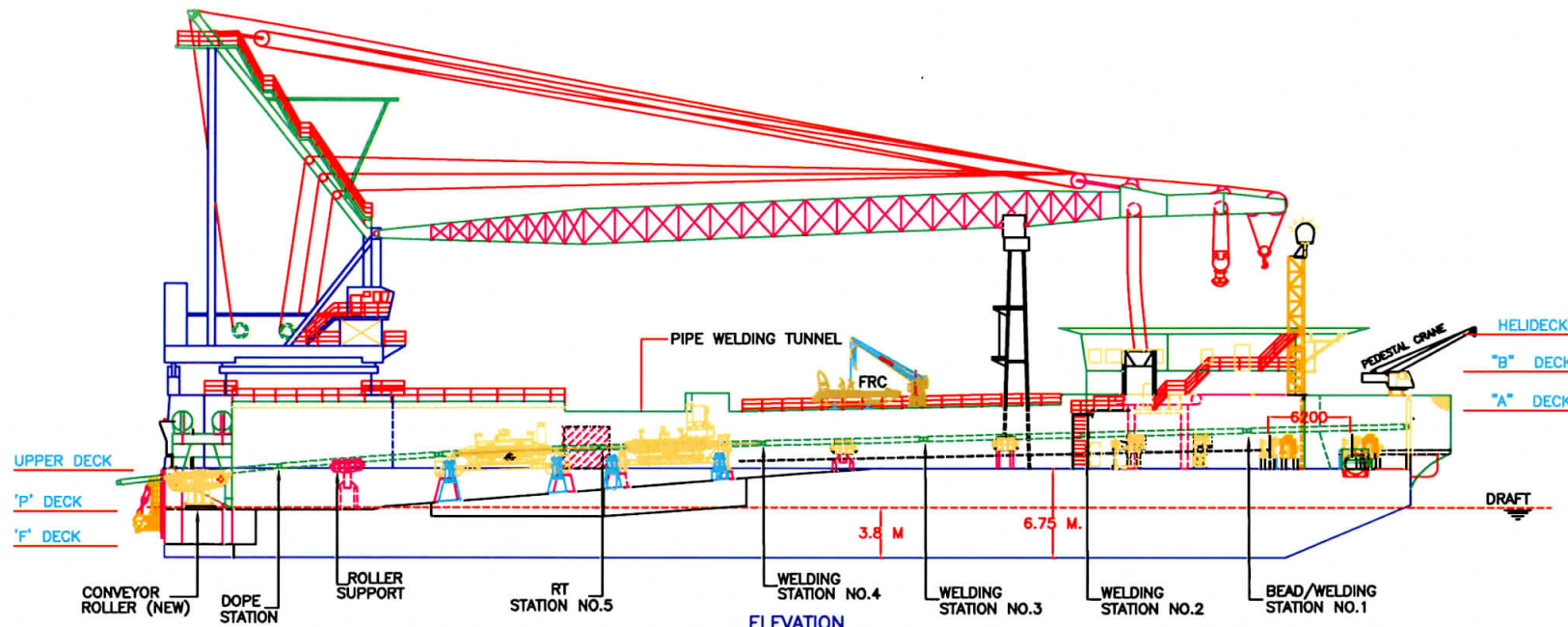

ELEVATION
(OTHER DETAILS ARE NOT SHOWN)

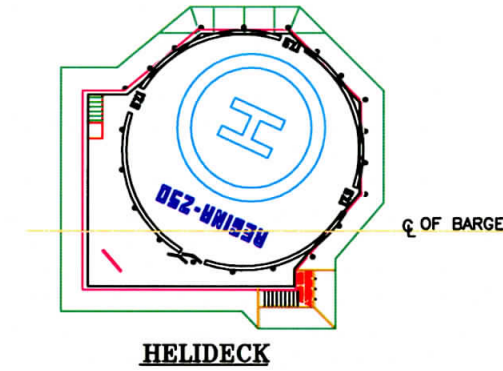

HELIDECK

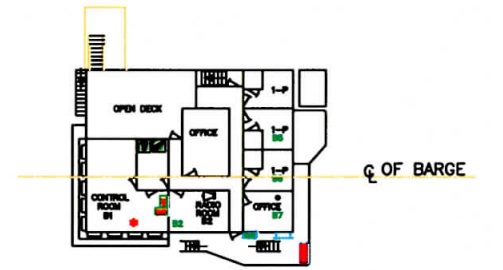

'B' DECK

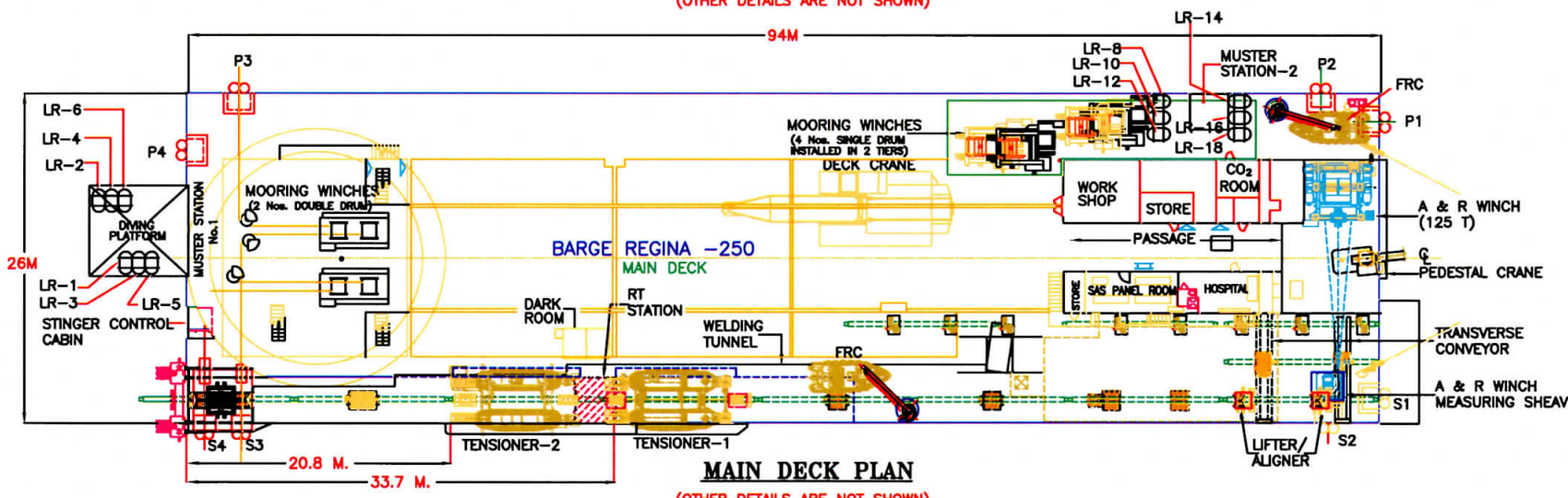

MAIN DECK PLAN
(OTHER DETAILS ARE NOT SHOWN)

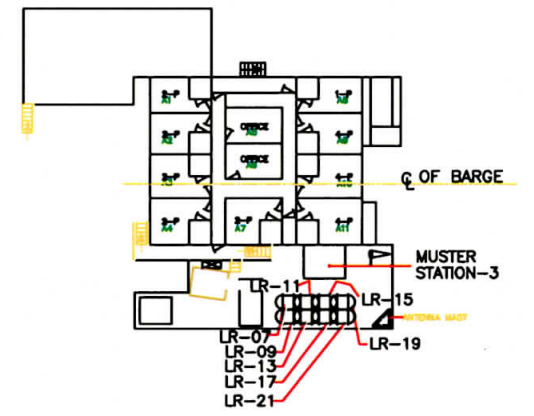

'A' DECK

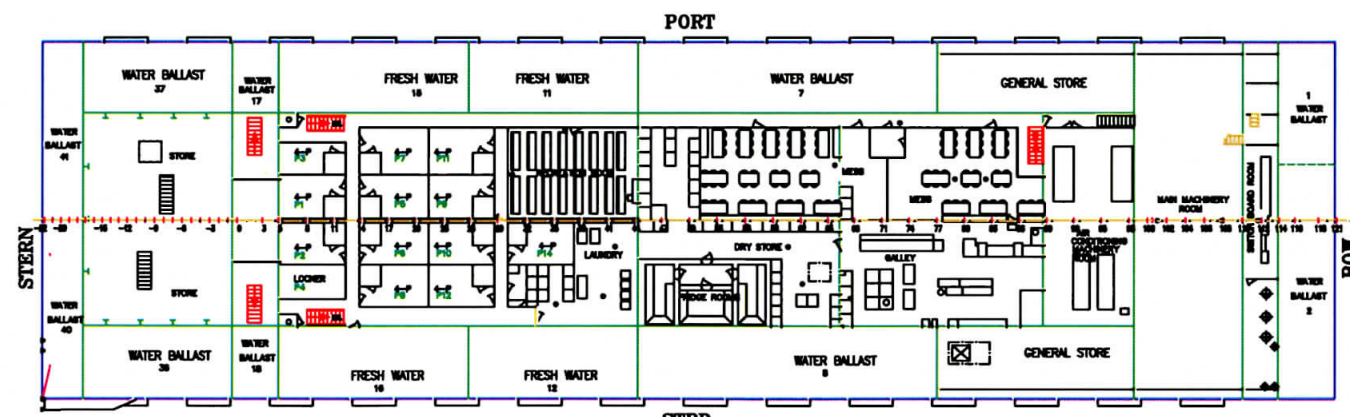

'P' DECK

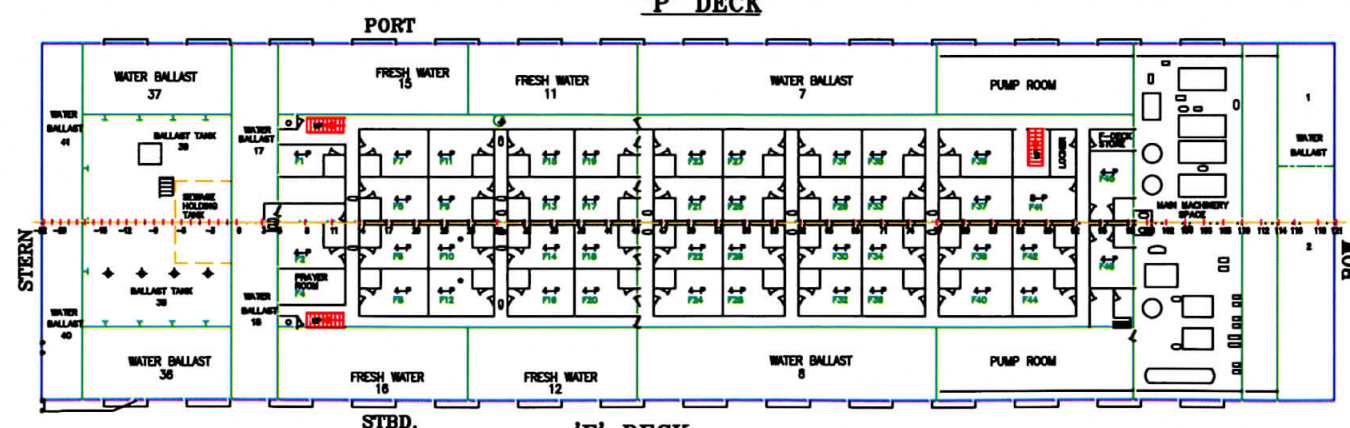

'F' DECK

PRINCIPAL DIMENSIONS

LENGTH - 94.00M
BREADTH - 26.00M
DEPTH - 6.75M

02	31-01-10	RE-ISSUED FOR INFORMATION	TKK	EKC	SVR	KGS	
01	18-01-10	RE-ISSUED FOR INFORMATION	ECM	EKC	SVR	KGS	
00	12-08-09	ISSUED FOR INFORMATION	TKK	ECM	KGS	KGS	
REV	DATE	DESCRIPTION	BY	CHK	RV'D	AP'D	
SCALE:	1:275	SIZE:	A1	DRAWN:	ECM	CHECKED:	EKC
MAIN CONTRACTOR/CLIENT:							
INTERNAL							
OWNER/PROJECT:							
INTERNAL							
VALENTINE MARITIME (GULF) L.L.C. ABU-DHABI, U.A.E.							
TITLE: DERRICK LAY BARGE REGINA-250 GA DRAWING							
JOB No.	DRAWING No.		SHEET No.		REV.		
	R250-BRG-GA-303		1 OF 1		02		